

marantz®

Model PM-14S1 Owner's Manual

Integrated Amplifier

SAFETY PRECAUTIONS



CAUTION
RISK OF ELECTRIC SHOCK
DO NOT OPEN



CAUTION:
TO REDUCE THE RISK OF ELECTRIC SHOCK, DO NOT REMOVE COVER (OR BACK). NO USER-SERVICEABLE PARTS INSIDE. REFER SERVICING TO QUALIFIED SERVICE PERSONNEL.



The lightning flash with arrowhead symbol, within an equilateral triangle, is intended to alert the user to the presence of uninsulated "dangerous voltage" within the product's enclosure that may be of sufficient magnitude to constitute a risk of electric shock to persons.



The exclamation point within an equilateral triangle is intended to alert the user to the presence of important operating and maintenance (servicing) instructions in the literature accompanying the appliance.

WARNING:
TO REDUCE THE RISK OF FIRE OR ELECTRIC SHOCK, DO NOT EXPOSE THIS APPLIANCE TO RAIN OR MOISTURE.



Hot
surface
mark

CAUTION:
HOT SURFACE. DO NOT TOUCH.

The top surface over the internal heat sink may become hot when operating this product continuously. Do not touch hot areas, especially around the "Hot surface mark" and the top panel.

PRECAUTION:
SURFACE CHAUDE. NE PAS TOUCHER.

La surface supérieure du dissipateur de chaleur peut devenir chaude si vous utilisez ce produit en continu. Ne touchez pas les zones chaudes, tout particulièrement vers l'inscription "Hot surface mark" et le panneau supérieur.

PRECAUCIÓN:
SUPERFICIE CALIENTE. NO TOCAR.

La superficie superior sobre el disipador de calor interno podría llegar a calentarse al operar este producto de forma continua.

No toque las áreas calientes, especialmente las situadas alrededor de la "Hot surface mark" y del panel superior.

IMPORTANT SAFETY INSTRUCTIONS

1. Read these instructions.
2. Keep these instructions.
3. Heed all warnings.
4. Follow all instructions.
5. Do not use this apparatus near water.
6. Clean only with dry cloth.
7. Do not block any ventilation openings.
Install in accordance with the manufacturer's instructions.
8. Do not install near any heat sources such as radiators, heat registers, stoves, or other apparatus (including amplifiers) that produce heat.
9. Do not defeat the safety purpose of the polarized or grounding-type plug. A polarized plug has two blades with one wider than the other. A grounding type plug has two blades and a third grounding prong. The wide blade or the third prong are provided for your safety. If the provided plug does not fit into your outlet, consult an electrician for replacement of the obsolete outlet.
10. Protect the power cord from being walked on or pinched particularly at plugs, convenience receptacles, and the point where they exit from the apparatus.
11. Only use attachments/accessories specified by the manufacturer.
12. Use only with the cart, stand, tripod, bracket, or table specified by the manufacturer, or sold with the apparatus. When a cart is used, use caution when moving the cart/apparatus combination to avoid injury from tip-over.
13. Unplug this apparatus during lightning storms or when unused for long periods of time.
14. Refer all servicing to qualified service personnel.
Servicing is required when the apparatus has been damaged in any way, such as power-supply cord or plug is damaged, liquid has been spilled or objects have fallen into the apparatus, the apparatus has been exposed to rain or moisture, does not operate normally, or has been dropped.
15. Batteries shall not be exposed to excessive heat such as sunshine, fire or the like.



CAUTION:

To completely disconnect this product from the mains, disconnect the plug from the wall socket outlet.

The mains plug is used to completely interrupt the power supply to the unit and must be within easy access by the user.

PRECAUTION:

Pour déconnecter complètement ce produit du courant secteur, débranchez la prise de la prise murale.

La prise secteur est utilisée pour couper complètement l'alimentation de l'appareil et l'utilisateur doit pouvoir y accéder facilement.

PRECAUCIÓN:

Para desconectar completamente este producto de la alimentación eléctrica, desconecte el enchufe del enchufe de la pared.

El enchufe de la alimentación eléctrica se utiliza para interrumpir por completo el suministro de alimentación eléctrica a la unidad y debe de encontrarse en un lugar al que el usuario tenga fácil acceso.

FCC INFORMATION (For US customers)

1. PRODUCT

This product complies with Part 15 of the FCC Rules. Operation is subject to the following two conditions: (1) this product may not cause harmful interference, and (2) this product must accept any interference received, including interference that may cause undesired operation.

2. IMPORTANT NOTICE: DO NOT MODIFY THIS PRODUCT

This product, when installed as indicated in the instructions contained in this manual, meets FCC requirements. Modification not expressly approved by Marantz may void your authority, granted by the FCC, to use the product.

3. NOTE

This product has been tested and found to comply with the limits for a Class B digital device, pursuant to Part 15 of the FCC Rules. These limits are designed to provide reasonable protection against harmful interference in a residential installation.

This product generates, uses and can radiate radio frequency energy and, if not installed and used in accordance with the instructions, may cause harmful interference to radio communications. However, there is no guarantee that interference will not occur in a particular installation. If this product does cause harmful interference to radio or television reception, which can be determined by turning the product OFF and ON, the user is encouraged to try to correct the interference by one or more of the following measures:

- Reorient or relocate the receiving antenna.
- Increase the separation between the equipment and receiver.
- Connect the product into an outlet on a circuit different from that to which the receiver is connected.
- Consult the local retailer authorized to distribute this type of product or an experienced radio/TV technician for help.

For Canadian customers:

CAN ICES-3(B)/NMB-3(B)

NOTE ON USE / OBSERVATIONS RELATIVES A L'UTILISATION / NOTAS SOBRE EL USO

| WARNINGS | AVERTISSEMENTS | ADVERTENCIAS |
|---|---|---|
| <ul style="list-style-type: none"> • Avoid high temperatures. • Allow for sufficient heat dispersion when installed in a rack. • Handle the power cord carefully. • Hold the plug when unplugging the cord. • Keep the unit free from moisture, water, and dust. • Unplug the power cord when not using the unit for long periods of time. • Do not obstruct the ventilation holes. • Do not let foreign objects into the unit. • Do not let insecticides, benzene, and thinner come in contact with the unit. • Never disassemble or modify the unit in any way. • Ventilation should not be impeded by covering the ventilation openings with items, such as newspapers, tablecloths or curtains. • Naked flame sources such as lighted candles should not be placed on the unit. • Observe and follow local regulations regarding battery disposal. • Do not expose the unit to dripping or splashing fluids. • Do not place objects filled with liquids, such as vases, on the unit. • Do not handle the mains cord with wet hands. • When the switch is in the OFF position, the equipment is not completely switched off from MAINS. • The equipment shall be installed near the power supply so that the power supply is easily accessible. • Do not keep the battery in a place exposed to direct sunlight or in places with extremely high temperatures, such as near a heater. | <ul style="list-style-type: none"> • Eviter des températures élevées. • Tenir compte d'une dispersion de chaleur suffisante lors de l'installation sur une étagère. • Manipuler le cordon d'alimentation avec précaution. • Tenir la prise lors du débranchement du cordon. • Protéger l'appareil contre l'humidité, l'eau et la poussière. • Débrancher le cordon d'alimentation lorsque l'appareil n'est pas utilisé pendant de longues périodes. • Ne pas obstruer les trous d'aération. • Ne pas laisser des objets étrangers dans l'appareil. • Ne pas mettre en contact des insecticides, du benzène et un diluant avec l'appareil. • Ne jamais démonter ou modifier l'appareil d'une manière ou d'une autre. • Ne pas recouvrir les orifices de ventilation avec des objets tels que des journaux, nappes ou rideaux. Cela entraverait la ventilation. • Ne jamais placer de flamme nue sur l'appareil, notamment des bougies allumées. • Veuillez à respecter les lois en vigueur lorsque vous jetez les piles usagées. • L'appareil ne doit pas être exposé à l'eau ou à l'humidité. • Ne pas poser d'objet contenant du liquide, par exemple un vase, sur l'appareil. • Ne pas manipuler le cordon d'alimentation avec les mains mouillées. • Lorsque l'interrupteur est sur la position OFF, l'appareil n'est pas complètement déconnecté du SECTEUR (MAINS). • L'appareil sera installé près de la source d'alimentation, de sorte que cette dernière soit facilement accessible. • Ne placez pas la pile dans un endroit exposé à la lumière directe du soleil ou dans des endroits présentant des températures extrêmement élevées, par exemple près d'un radiateur. | <ul style="list-style-type: none"> • Evite altas temperaturas. • Permita la suficiente dispersión del calor cuando está instalado en la consola. • Maneje el cordón de energía con cuidado. • Sostenga el enchufe cuando desconecte el cordón de energía. • Mantenga el equipo libre de humedad, agua y polvo. • Desconecte el cordón de energía cuando no utilice el equipo por mucho tiempo. • No obstruya los orificios de ventilación. • No deje objetos extraños dentro del equipo. • No permita el contacto de insecticidas, gasolina y diluyentes con el equipo. • Nunca desarme o modifique el equipo de ninguna manera. • La ventilación no debe quedar obstruida por haberse cubierto las aperturas con objetos como periódicos, manteles o cortinas. • No deberán colocarse sobre el aparato fuentes inflamables sin protección, como velas encendidas. • A la hora de deshacerse de las pilas, respete la normativa para el cuidado del medio ambiente. • No exponer el aparato al goteo o salpicaduras cuando se utilice. • No colocar sobre el aparato objetos llenos de líquido, como jarros. • No maneje el cable de alimentación con las manos mojadas. • Cuando el interruptor está en la posición OFF, el equipo no está completamente desconectado de la alimentación MAINS. • El equipo se instalará cerca de la fuente de alimentación de manera que resulte fácil acceder a ella. • No coloque las pilas en un lugar expuesto a la luz directa del sol o donde la temperatura sea extremadamente alta, como cerca de una calefacción. |

Cautions on installation Précautions d'installation Emplazamiento de la instalación

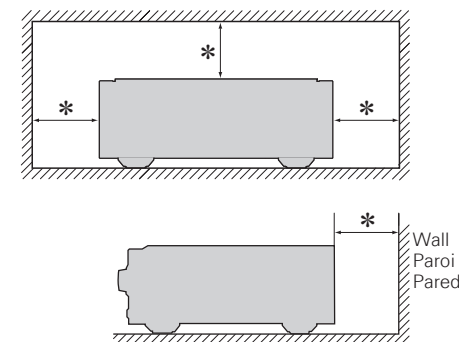

* For proper heat dispersal, do not install this unit in a confined space, such as a bookcase or similar enclosure.

- More than 12 in. (0.3 m) is recommended.

* Pour permettre la dissipation de chaleur requise, n'installez pas cette unité dans un espace confiné tel qu'une bibliothèque ou un endroit similaire.

- Une distance de plus de 12 po (0,3 m) est recommandée.

* Para la dispersión del calor adecuadamente, no instale este equipo en un lugar confinado tal como una librería o unidad similar.

- Se recomienda dejar más de 12 pulg. (0,3 m) alrededor.

PROPOSITION 65 WARNING (California only)

This product contains a chemical known to the State of California to cause cancer and birth defects or other reproductive harm.

For more information go to www.p65warnings.ca.gov

Preparation

Thank you for purchasing this Marantz product. To ensure proper operation, please read this owner's manual carefully before using the product. After reading the manual, be sure to keep it for future reference.

Contents

| | |
|--|----|
| Preparation | 1 |
| Accessories | 1 |
| About the remote control | 2 |
| Inserting the batteries | 2 |
| Operating range of the remote control unit | 2 |
| Cautions on handling | 2 |
| Features | 3 |
| Part names and functions | 4 |
| Front panel | 4 |
| Rear panel..... | 5 |
| Remote control unit..... | 6 |
| Connections | 7 |
| Cables used for connections | 7 |
| Connecting the speakers | 7 |
| Connecting the speakers cables | 7 |
| Speaker connections | 8 |
| Connecting players | 8 |
| Connecting recorders | 9 |
| F.C.B.S. connection | 10 |
| Preparation for F.C.B.S. connection..... | 10 |
| Stereo complete bi-amp connection..... | 11 |
| Connection for 5.1 multi-channel playback..... | 12 |
| Connecting P.DIRECT IN connectors | 14 |
| Connecting PRE OUT connectors | 14 |
| Connecting devices with remote control connectors | 15 |
| Performing operations by RC on this unit without visual contact | 15 |
| Remotely connecting Marantz devices | 15 |
| Connecting the power cord | 15 |

| | |
|---|----|
| Playback | 16 |
| Turning the power on | 16 |
| Turning the power standby | 16 |
| Turning the power off..... | 16 |
| Turning speaker output on | 16 |
| Selecting the input source | 16 |
| Adjusting the volume | 16 |
| Turning off the sound temporarily | 17 |
| Setting the attenuation level when sound is muted..... | 17 |
| Adjusting the left and right channel balance | 17 |
| Adjusting the tone | 17 |

| | |
|--|----|
| Settings | 18 |
| Setting ID number for F.C.B.S | 18 |
| Setting the power amp direct mode | 18 |
| Turning power amp direct mode on | 18 |
| Turning power amp direct mode off | 18 |
| Switching the illumination lamp setting | 19 |
| Turning the illumination lamp off..... | 19 |
| Turning the illumination lamp on | 19 |
| Setting the Auto Standby mode | 19 |
| Turning Auto Standby mode off | 19 |
| Turning Auto Standby mode on..... | 19 |

| | |
|------------------------------|----|
| Tips | 20 |
| Tips | 20 |
| Troubleshooting | 20 |
| Error messages | 23 |

| | |
|---|----|
| Appendix | 24 |
| Explanation terms | 24 |
| About the protection circuit | 24 |
| Specifications | 25 |
| Index | 25 |

Accessories

Check that the following parts are supplied with the product.

- | | |
|------------------------------------|---|
| ① Owner's manual..... | 1 |
| ② Warranty card (for USA) | 1 |
| ③ Warranty card (for CANADA) | 1 |
| ④ Power cord..... | 1 |
| ⑤ Remote control (RC001PMSA) | 1 |
| ⑥ R03/AAA batteries | 2 |

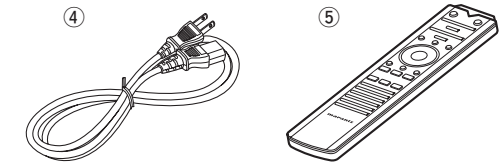

About the remote control

The supplied remote control can be used to control Marantz Integrated Amplifier and Marantz Super Audio CD player.

- The remote control may not operate some products.

Inserting the batteries

- 1 Remove the rear lid in the direction of the arrow and remove it.

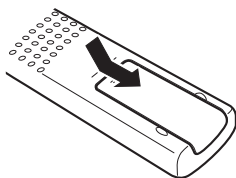

- 2 Load the two batteries properly as indicated by the marks in the battery compartment.

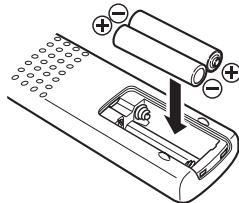

- 3 Put the rear cover back on.

NOTE

- Insert the specified batteries in the remote control unit.
- Replace the batteries with new ones if the set does not operate even when the remote control unit is operated close to the unit. (The supplied batteries are only for verifying operation. Replace them with new batteries at an early date.)
- When inserting the batteries, be sure to do so in the proper direction, following the \oplus and \ominus marks in the battery compartment.
- To prevent damage or leakage of battery fluid:
 - Do not use a new battery together with an old one.
 - Do not use two different types of batteries.
 - Do not attempt to charge dry batteries.
 - Do not short-circuit, disassemble, heat or dispose of batteries in flames.
 - Do not keep the battery in a place exposed to direct sunlight or in places with extremely high temperatures, such as near a heater.
- If the battery fluid should leak, carefully wipe the fluid off the inside of the battery compartment and insert new batteries.
- Remove the batteries from the remote control unit if it will not be in use for long periods.
- Used batteries should be disposed of in accordance with the local regulations regarding battery disposal.
- The remote control unit may function improperly if rechargeable batteries are used.

Operating range of the remote control unit

Point the remote control unit at the remote sensor when operating it.

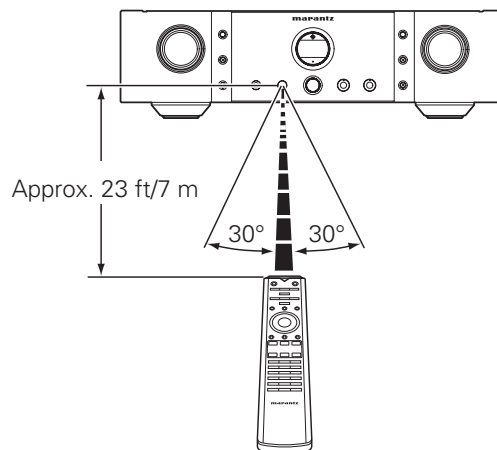

NOTE

- The set may function improperly or the remote control unit may not operate if the remote control sensor is exposed to direct sunlight, strong artificial light from an inverter type fluorescent lamp or infrared light.
- When using 3D video devices that transmit radio communication signals (such as infrared signals etc) between the various units (such as the monitor, 3D glasses, 3D transmitter unit etc), the remote control unit may not operate due to interference from those radio communication signals. If this occurs, adjust the direction and distance of the 3D communication for each unit, and check that the remote control unit operation is not affected by these signals.

Cautions on handling

• Before turning the power on

Check once again that all connections are correct and that there are no problems with the connection cables.

- Power is supplied to some of the circuitry even when the unit is set to the standby mode. When going on vacation or leaving home for long periods of time, be sure to unplug the power cord from the power outlet.

• About condensation

If there is a major difference in temperature between the inside of the unit and the surroundings, condensation (dew) may form on the operating parts inside the unit, causing the unit not to operate properly.

If this happens, let the unit sit for an hour or two with the power turned off and wait until there is little difference in temperature before using the unit.

• Cautions on using mobile phones

Using a mobile phone near this unit may result in noise. If that occurs, move the mobile phone away from this unit when it is in use.

• Moving the unit

Turn off the power and unplug the power cord from the power outlet. Next, disconnect the connection cables to other system units before moving the unit.

• About care

- Wipe the cabinet and control panel clean with a soft cloth.
- Follow the instructions when using a chemical cleaner.
- Benzene, paint thinner or other organic solvents as well as insecticide may cause material changes and discoloration if brought into contact with the unit, and should therefore not be used.

Features

HDAM®SA3 Module

This unit includes the HDAM®SA3 which had been developed for high-end models. The HDAM®SA3 is incorporated into many components, such as the current feedback phono equalizer.

Constant Current Feedback Phono Equalizer

This unit incorporates the constant current feedback phono equalizer which had been developed for high-end models. This equalizer, developed by Marantz, has the advantages of both NF-type and CR-type phono equalizers, and it supports both MM and MC cartridges.

Linear Control Volume

The control knob had adopted the high-end model design concept. For better S/N ratio, the MAS6116 from Micro Analog Systems and the HDAM®SA3 have been combined, which enables smooth adjustment in the range of 0 to -100 dB in units of ± 0.5 dB.

F.C.B.S.

A Floating Control Bus System (F.C.B.S.) enables the user to connect up to four PM-14S1 units, making a diversity of applications possible with complete bi-amp and multichannel connections. Moreover, a ground loop is not formed among multiple PM-14S1 units connected; therefore, sound quality is not adversely affected.

BI-AMP Mode

Complete bi-amp connection proposed by Marantz enables a level of reproduction of the acoustic field never before achieved. Synchronized operation of two PM-14S1 units is made possible by F.C.B.S. (Floating Control Bus System) connection, with each PM-14S1 in Bi-Amp mode working as a monaural integrated amplifier.

Power Amplifier Direct In Mode

In this mode, this unit works as a power amplifier. This mode will be useful in home theater systems.

Display

This unit adopts an LCD (Liquid Crystal Display) to display the input source and volume level. Compared with other types of display panels, an LCD requires less drive power and generates less radiation noise, which minimizes any adverse effect on sound quality.

Part names and functions

For buttons not explained here, see the page indicated in parentheses ().

Front panel

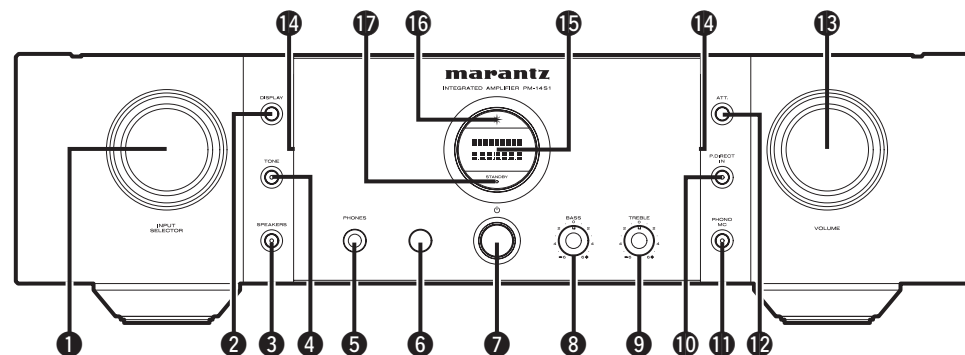

1 INPUT SELECTOR knob

This selects the input source (☞ page 16).

2 DISPLAY button

This turns the illumination lamp on/off (☞ page 19).

3 Speaker output button/indicator (SPEAKERS)

This switches speaker output on/off (☞ page 16).

- Indicates the status of the unit's as follows:
 - Speaker on: Blue
 - Speaker off: Off

4 TONE button/indicator

This turns the tone control on/off (☞ page 17).

- Indicates the status of the unit's as follows:
 - Tone control on: Blue
 - Tone control off: Off

5 Headphone jack (PHONES)

Used to connect headphones.

- Turn off speaker output when using headphones (☞ page 16).

NOTE

To prevent hearing loss, do not raise the volume level excessively when using headphones.

6 Remote control sensor

This receives signals from the remote control unit (☞ page 2).

7 Power operation button (⏻)

This turns the power on/off (☞ page 16).

8 BASS control knob

This adjusts the bass (☞ page 17).

9 TREBLE control knob

This adjusts the treble (☞ page 17).

10 Power amplifier direct mode button/indicator (P.DIRECT IN)

This switches the power amp direct mode on/off (☞ page 18).

- Indicates the status of the unit's as follows:
 - Power amplifier direct mode on: Blue
 - Power amplifier direct mode off: Off

11 Phono equalizer button/indicator (PHONO MC)

This switch is set according to the type of player cartridge to be used.

Set this switch to MM or MC according to the type of cartridge used on your turntable.

- Indicates the status of the unit's as follows:
 - MC: Blue
 - MM: Off

12 Attenuator button (ATT.)

This mutes the volume (☞ page 17).

13 VOLUME control knob

This adjusts the volume level (☞ page 16).

14 Illumination lamp

The illumination lamp lights (blue).

15 Display

This displays various pieces of information.

16 POWER indicator

This is lit as follows according to the power status :

- Power on : Blue
- Standby : Off
- Power off : Off

17 STANDBY indicator

This is lit as follows according to the power status :

- Power on : Off
- Standby : Red
- Power off : Off

Rear panel

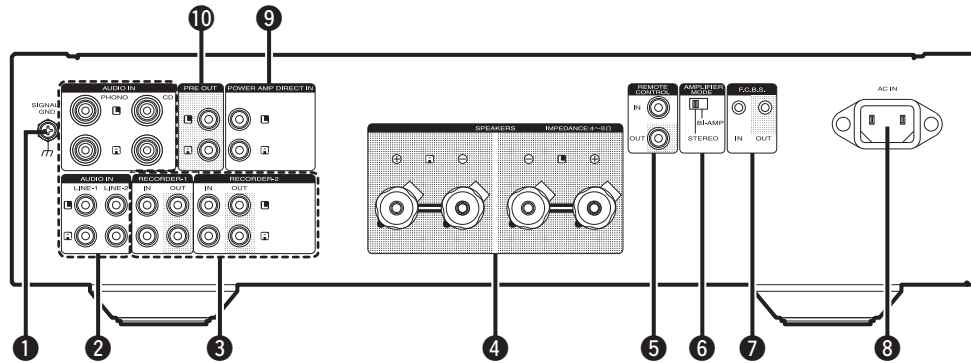

- 1 SIGNAL GND (ground) terminal**
Used to connect the earth wire of a turntable.

NOTE

This terminal is not a safety ground.

- 2 Audio input connectors (AUDIO IN)**
Used to connect devices equipped with analog audio connectors (page 8).
- 3 Input/output connectors (Recordings) (RECORDER-1, RECORDER-2)**
Used to connect to a recording device (page 9).
- 4 Speaker system terminals (SPEAKER SYSTEMS)**
Used to connect speakers (page 7).
- 5 REMOTE CONTROL connectors**
Used to connect to a Marantz audio device that is compatible with the remote control function (page 15).

- 6 AMPLIFIER MODE switch**
Used to switch the amplifier mode (STEREO/BI-AMP) (page 11, 12).
- 7 F.C.B.S. connectors**
Used to connect a high quality playback system using two or more of these units (page 10).
- 8 AC inlet (AC IN)**
Used to connect the power cord (page 15).
- 9 Power amplifier direct connectors (POWER AMP DIRECT IN)**
Used to connect a pre-amplifier when this unit is used as a power amplifier (page 14).
- 10 PRE OUT connectors**
Use this to add such equipment as a power amplifier or subwoofer (page 14).

Remote control unit

Buttons for amplifier

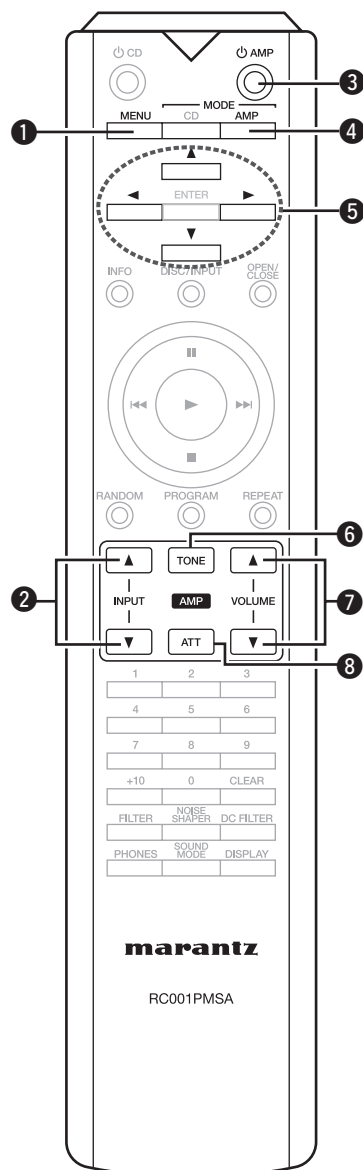

- ❶ **MENU button**
This displays the volume balance adjustment menu (☞ page 17).
- ❷ **Input source select buttons (INPUT ▲▼)**
This selects the input source (☞ page 16).
- ❸ **Amplifier power button (⏻ AMP)**
This turns the power on/off (standby) (☞ page 16).
- ❹ **Remote control mode button (AMP MODE)**
This switches the remote control to amplifier control mode.
- ❺ **Cursor buttons (▲▼◀▶)**
This adjusts the volume balance output from the left and right speakers (☞ page 17).
- ❻ **Tone control button (TONE)**
This turns the tone control on/off (☞ page 17).
- ❼ **Volume control buttons (VOLUME ▲▼)**
This adjusts the volume level (☞ page 16).
- ❽ **Attenuator button (ATT)**
This mutes the volume (☞ page 17).



- The supplied remote control can be used to control Marantz Integrated Amplifier and Marantz Super Audio CD player.
- When using this remote control, also refer to the operating instructions of the other devices.

NOTE

The remote control may not operate some products.

Buttons for Super Audio CD player

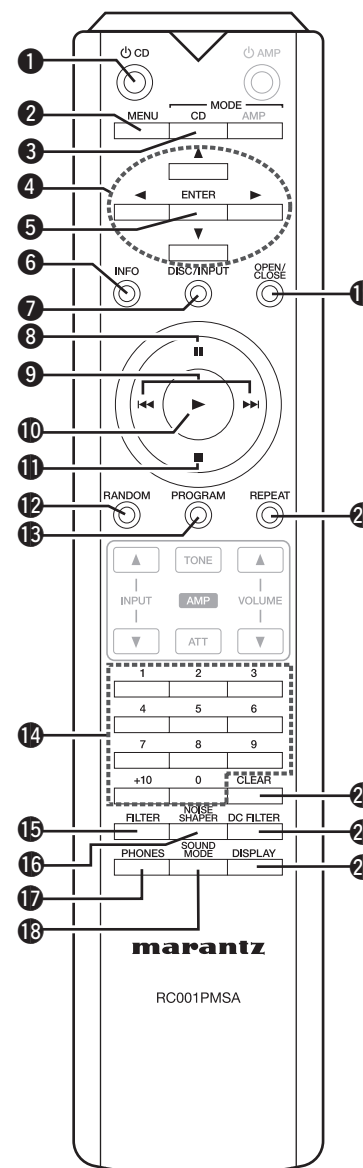

- ❶ Super Audio CD player power button (⏻ CD)
- ❷ MENU button
- ❸ Remote control mode button (CD MODE)
- ❹ Cursor buttons (▲▼◀▶)
- ❺ ENTER button
- ❻ Information display button (INFO)
- ❼ Input source select buttons (DISC/INPUT)
- ❽ Pause button (⏸)
- ❾ Skip buttons (⏮◀▶⏭)
- ❿ Playback button (▶)
- ⓫ Stop button (■)
- ⓬ RANDOM button
- ⓭ PROGRAM button
- ⓮ REPEAT button
- ⓯ Number buttons (0 – 9, +10)
- ⓰ FILTER button
- ⓱ NOISE SHAPER button
- ⓲ PHONES button
- ⓳ SOUND MODE button
- ⓴ Disc tray open/close button (OPEN/CLOSE)
- ⓵ CLEAR button
- ⓶ DC FILTER button
- ⓷ DISPLAY button

Connections

NOTE

- Disconnect this unit's power plug from the power outlet before connecting the speakers.
- Connect the speaker cables so they do not stick out of the speaker terminals. The protection circuit may be activated if the wires touch the rear panel or if the + and - sides touch each other (see page 24 "Protection circuit").
- Never touch the speaker terminals while the power cord is connected. Doing so could result in electric shock.
- Use speakers with an impedance of 4 – 8 Ω/ohms.

Cables used for connections

Provide necessary cables according to the devices you want to connect.

| | |
|------------------------|--|
| Speaker cable | |
| Audio cable | |
| Remote connector cable | |

Connecting the speakers

Connecting the speakers cables

Carefully check the left (L) and right (R) channels and + (red) and - (white) polarities on the speakers being connected to the unit, and be sure to connect the channels and polarities correctly.

1 Peel off about 3/8 inch (10 mm) of sheathing from the tip of the speaker cable, then either twist the core wire tightly or apply solder to it.



2 Turn the speaker terminal counterclockwise to loosen it.

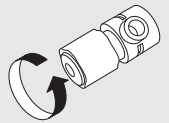

3 Insert the speaker cable's core wire to all the way into the speaker terminal.

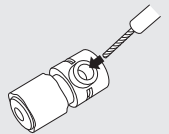

4 Turn the speaker terminal clockwise to tighten it.

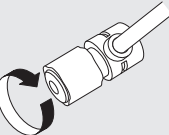

| Spade lug connector | When using a banana plug |
|---------------------|---|
| | Tighten the speaker terminal firmly before inserting the banana plug. |

Speaker connections

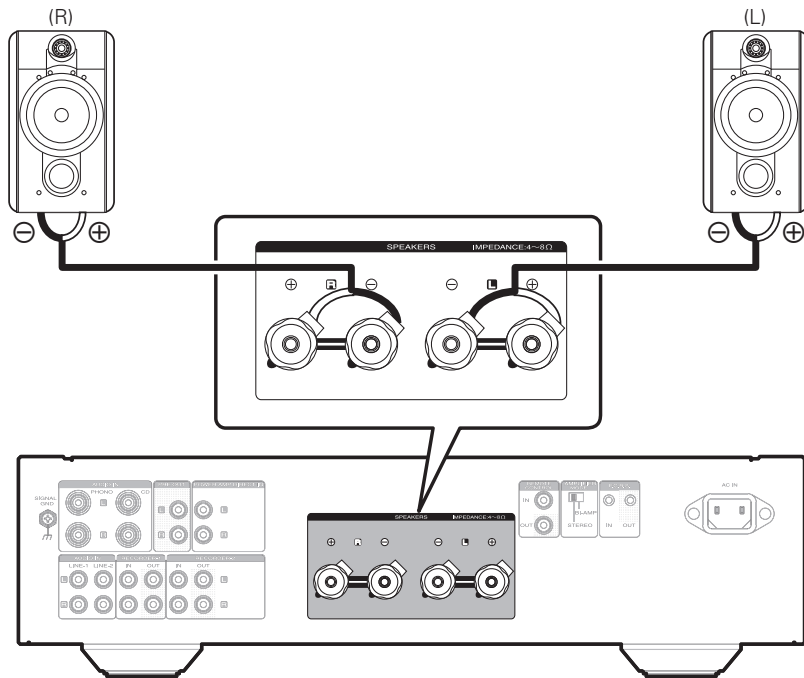

Connecting players

You can connect turntables, tuners, CD players and network audio players to this unit. Set phono equalizer button by the type of your cartridge to be used MM or MC. If you set this unit's input source to "PHONO" and you accidentally increase the volume without having a turntable connected, you may hear a hum noise from the speakers.

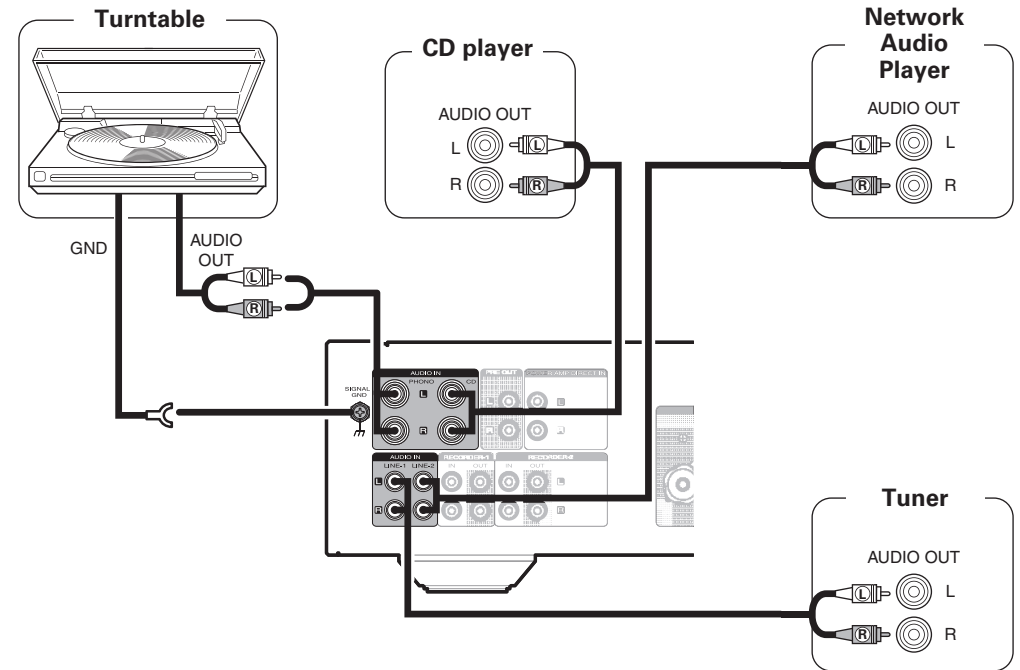

NOTE

The ground line (SIGNAL GND) on this unit is not a safety ground. Connect it to reduce noise when noise is excessive. Note that depending on the turntable, connecting the ground line may have the reverse effect of increasing noise. In this case, it is not necessary to connect the ground line.

Connecting recorders

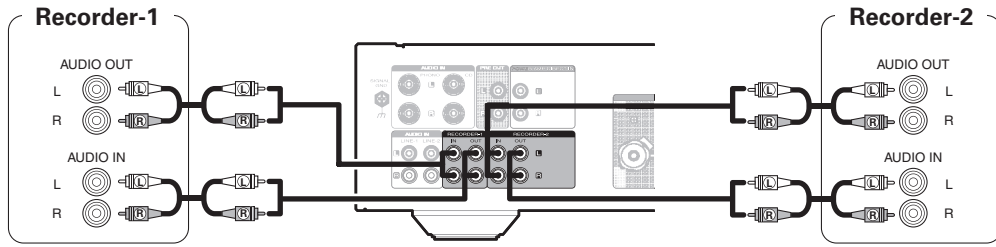

F.C.B.S. connection

The Marantz F.C.B.S. (Floating Control Bus System) is the high quality sound system for link control between multiple PM-14S1 units (up to 4 units). Each unit is controlled via its ID number registered beforehand.

The ID numbers need to be set to an operating unit (master) and a subordinate unit (slave) receiving the command from the master. For slave units, register ID numbers in the order of command reception from the master.

Once registered the ID numbers, the units will enable link control operations such as input selection, volume control, on/off selection of muting, display, tone control, etc.

Furthermore, F.C.B.S. connection of multiple units has the feature that switches this unit's output from stereo to monaural so that the unit can work as a monaural output amplifier. Follow the respective instructions to make the necessary settings.

For details on the ID number settings, see  page 18 "Setting ID number for F.C.B.S."

Preparation for F.C.B.S. connection

□ Making the F.C.B.S. connection

To use multiple PM-14S1 units, make this connection in addition to audio connection. For details on each connection feature, refer to the respective instructions.

Prepare the correct number of portable audio connection cables for the number of units to be connected. Either of the following types of connection cables are adequate.

- Monaural mini plug \longleftrightarrow monaural mini plug connecting cable

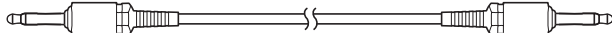

- Stereo mini plug \longleftrightarrow stereo mini plug connecting cable

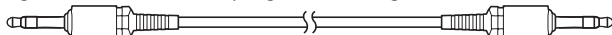

NOTE

Do not use connecting cables that contain resistance.

□ Connection example

In the connection of the following example, an unit with ID number 1 acts as a master amplifier to control all the other slave units with ID numbers 2 to 4.

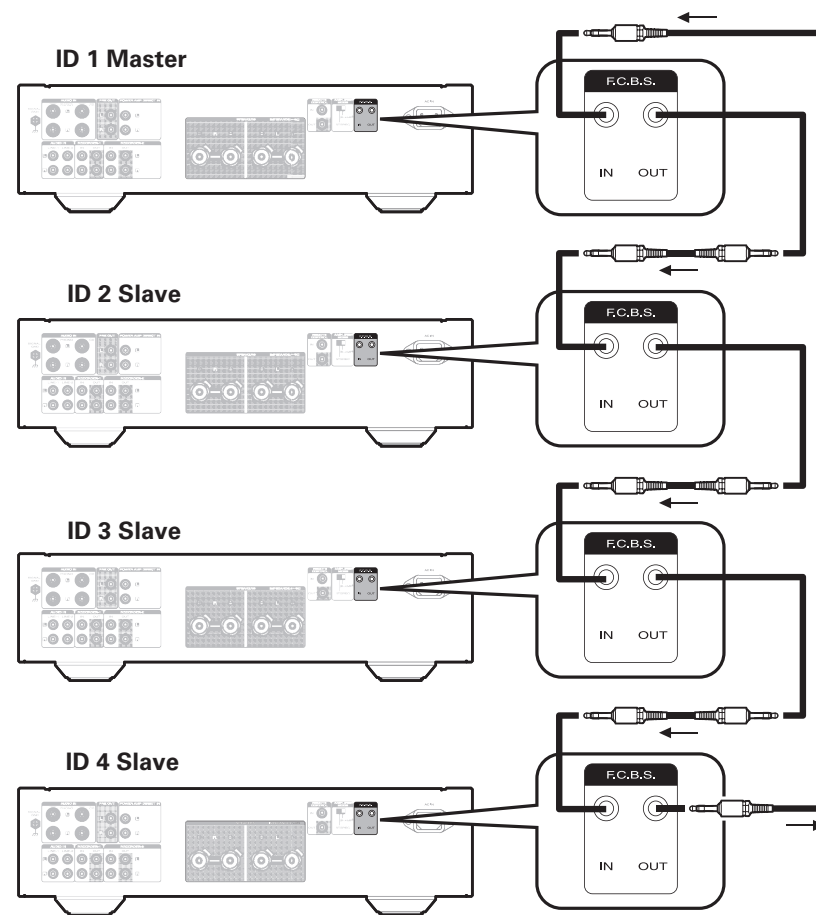

NOTE

- The PM-14S1 F.C.B.S. function is only valid between the same PM-14S1 models. This function may not operate correctly if other Marantz models (PM-11S3, etc.) are connected.
- To turn the power of multiple F.C.B.S.-connected units on/off, switch the power on in order of lowest to highest ID number, and switch the power off in order of highest to lowest ID number.

Stereo complete bi-amp connection

This mode enables the two amplifiers connected to this unit to function as one monaural amplifier. To use this mode, two F.C.B.S. connected PM-14S1 units are required. To switch the mode, use the amplifier mode switch on the rear panel while the power is off.



The figures below show example displays in the stereo and bi-amp modes.

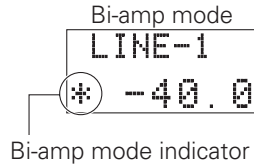
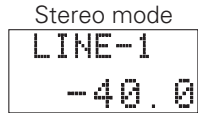

In bi-amp mode, connect to the left channel input jack. The right channel input is disabled. The same signals are output from the left and right output jacks.

NOTE

- Always turn the power to the unit off before changing the operating mode switch setting. Turning the power on again activates the new setting.
- When in bi-amp mode, the R channel input jacks cannot be used.
- When in bi-amp mode, the signals input into the L channel are output from both channels. Therefore, the same signals are output from the L channel and R channel in RECORDER OUT, PRE OUT, PHONES OUT.
- Speaker systems connected using complete bi-amp connections must support bi-amp connections. Before connecting your speakers, check in the owner's manual that came with the speakers or contact the manufacturer to confirm whether they support bi-amp connection.

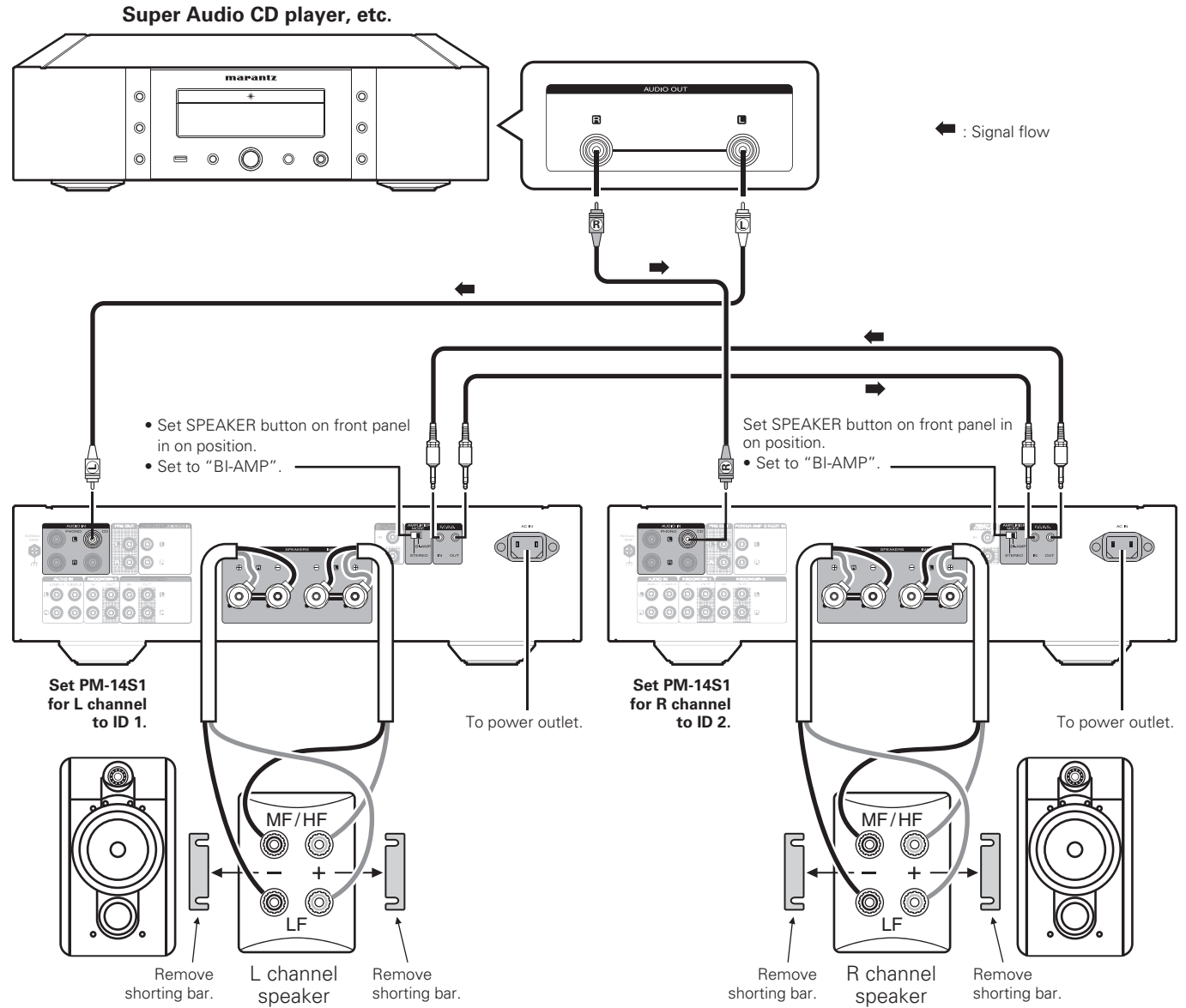

Connection for 5.1 multi-channel playback

The three units are connected using F.C.B.S. For the F.C.B.S connection, prepare 3 audio connection cables, and refer to F.C.B.S. (page 10).

Connect the outputs of players that have 5.1 channel analog outputs to each of the three units.

If using a subwoofer, see the owner's manual that came with the subwoofer for further instructions.

Set the ID numbers for the three amplifiers as explained in How to set ID number for F.C.B.S. (page 18).

- When the ID 1 unit is operated, ID 2 and ID 3 units will operate in sync.

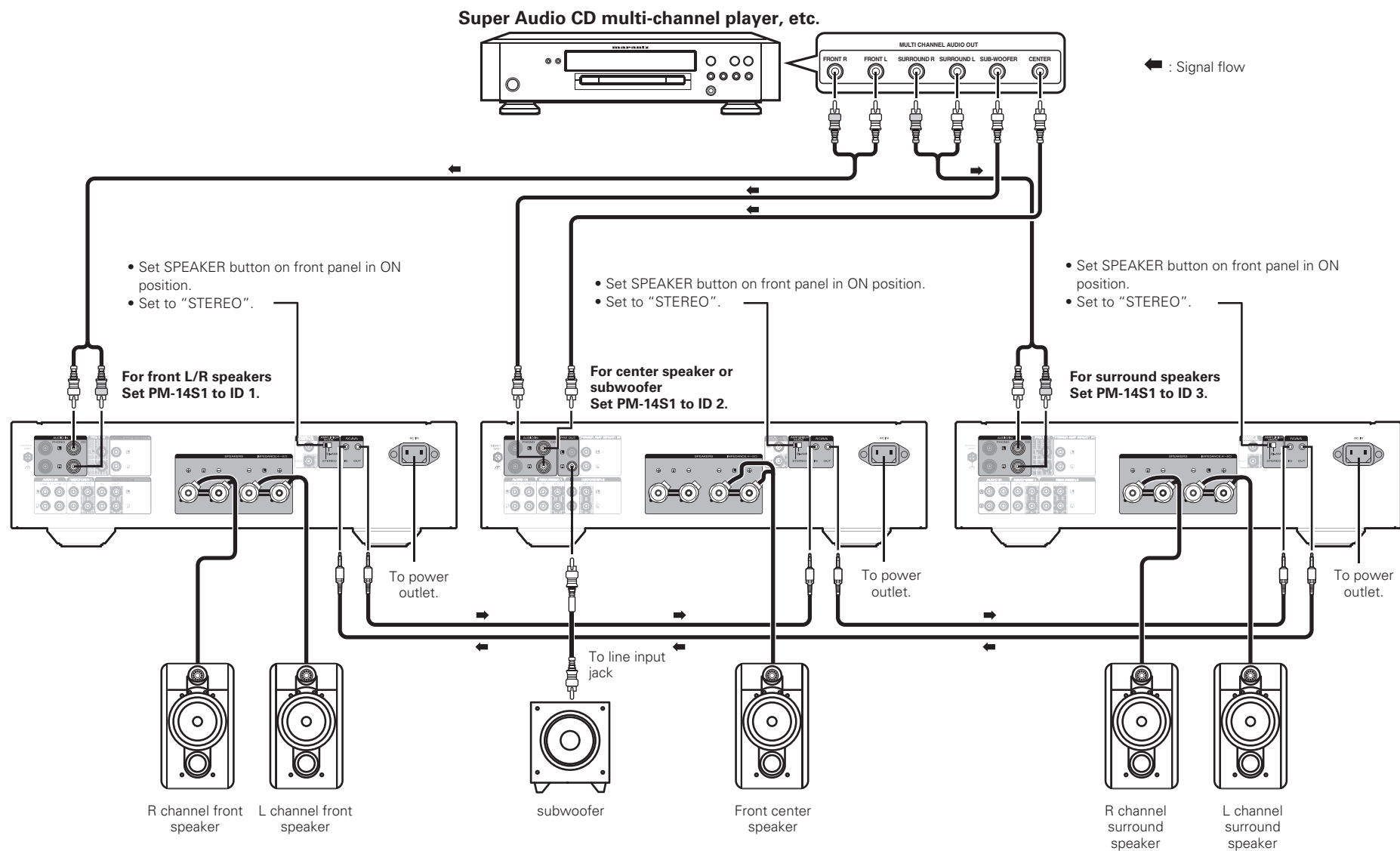

□ Speaker positioning for Super Audio CD multi-channel sound

In order to enjoy Super Audio CD multi-channel sound with the best possible acoustics, it is recommended to position speakers as specified in ITU-R BS.775-1 of the International Telecommunication Union (ITU). Super Audio CD multi-channel discs are recorded and mixed so as to achieve the optimum effect with a speaker system laid out as specified in ITU-R BS.775-1.

- With Super Audio CD multi-channel discs, the music signals are basically recorded using 5 channels (3 – 6 channels sometimes), but in some cases, LFE (for subwoofer) is recorded as a sixth channel.
- Each disc indicates how many channels have been recorded on it.
- The basic layout is 3 speakers in the front and 2 in the back since multi-channel discs usually have 5 channels. The 2 front, 1 center and 2 surround (rear) speakers should be set in a circle around the listening point. If using speakers of differing sizes, adjust volume balance from the amplifier.
- The location of the subwoofer in the figure is just for explanatory purposes. It can be located anywhere in the room. For connection and positioning instructions, see the owner's manual that came with the subwoofer.

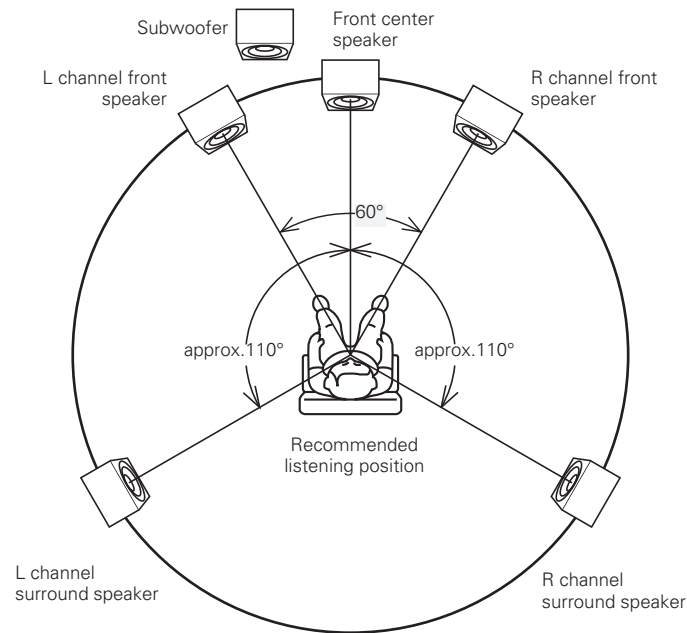

- ITU (International Telecommunication Union)
The ITU is a special organization of the United Nations. It consists of a number of organs, one of which is the Radio Broadcasting Section.
ITU-R BS is the recommendation which consists of standards relating to broadcasting (audio) operations, one of which is the ITU-R BS.775-1 which governs multi-channel stereo sound systems.

Connecting P.DIRECT IN connectors

If you use a pre-amplifier, connect it as shown below, and then you can use this unit as a power amplifier.

Press and hold P.DIRECT IN on the unit for 3 seconds or longer.

- The power amp direct mode setting changes with each press of the button.
- If the mode is set to on, the display shows "POWER AMP DIRECT".
- **On** : Allows the device connected to the Power Amp Direct connector to be played.
- **Off** (Default): Allows the program source selected using INPUT SELECTOR to be played.

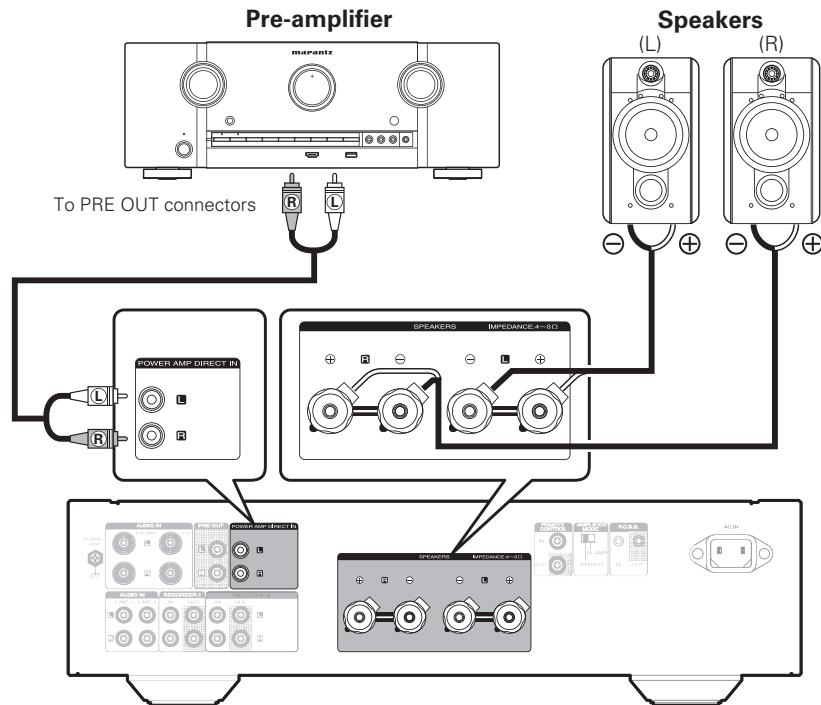

NOTE

- When the power amp direct mode is on, adjustment of the volume, balance and tone on the main unit has no effect. Adjust the volume on the pre-amplifier.
- When the power amp direct mode is on, the main unit outputs at maximum volume. Check the output level on the input device before playing it and adjust the volume accordingly.

Connecting PRE OUT connectors

If you use a power amplifier, connect it as shown below, and then you can use this unit as a pre-amplifier.

- For connecting speaker systems, refer to the owner's manual supplied with the power amplifier to be used.

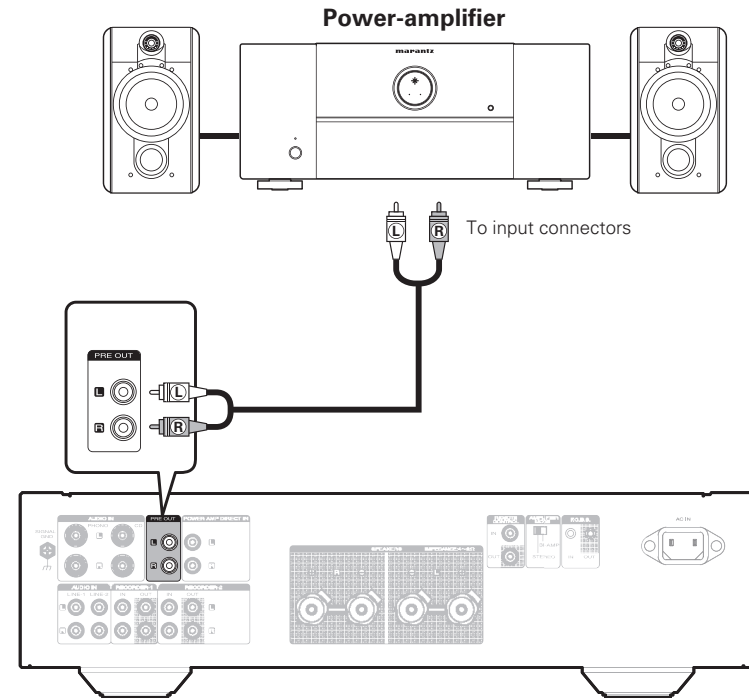

NOTE

The power amp direct mode and the PRE OUT function cannot work at the same time.

Connecting devices with remote control connectors

Performing operations by RC on this unit without visual contact

You can connect an external IR receiver to the REMOTE CONTROL connectors to perform operations on this unit with the supplied remote control unit without visual contact. This might be necessary if the unit is hidden in a cupboard or corner, so you can't directly point with the remote control unit to the device.

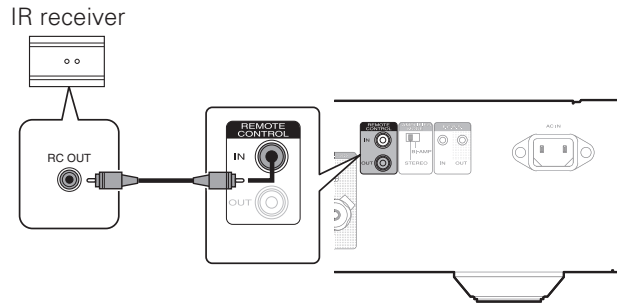

Remotely connecting Marantz devices

You can transmit remote control signals simply by connecting a Marantz audio device to the REMOTE CONTROL IN/OUT connectors using the remote connection cable provided with the device.

Set the remote control switch located on the rear panel of the connected audio component to "EXTERNAL" to use this feature.

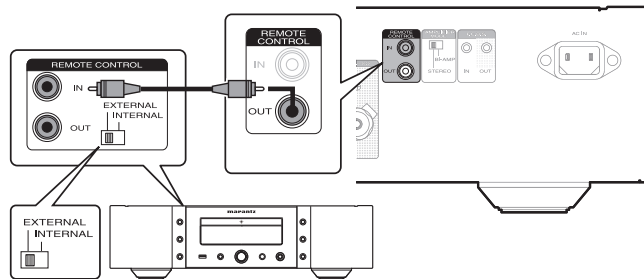

Connecting the power cord

Wait until all connections have been completed before connecting the power cord.

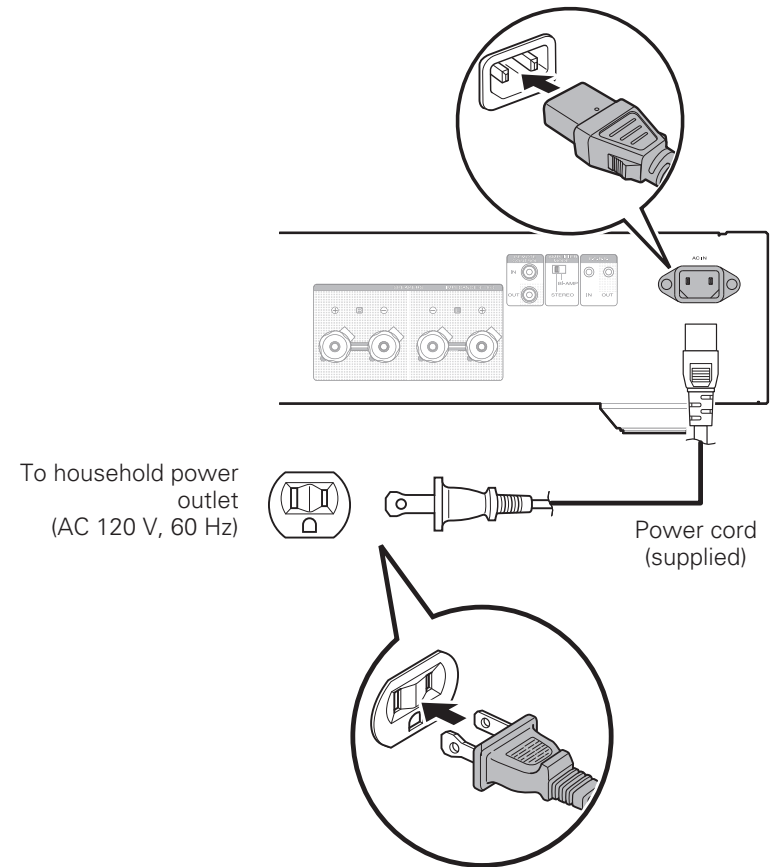

Playback

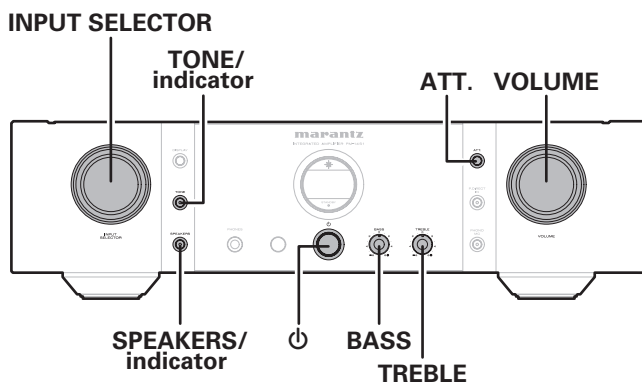
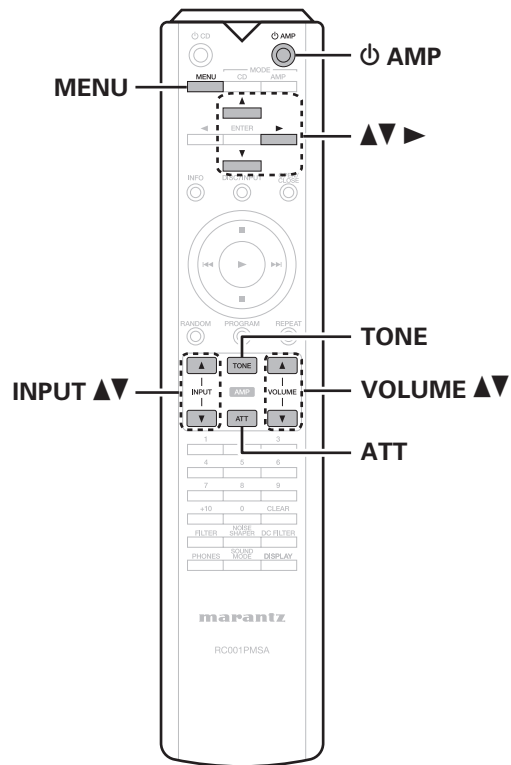

Turning the power on

Press **AMP** on the unit.

- The power indicator lights in blue.
- The unit will be ready to start playback after several seconds.

Turning the power standby

Press **AMP**.

- The power is set to the standby mode.
- The Standby status indicator lights in red.



- Press **AMP** to turn on power from standby mode.
- You can also turn on power by using either INPUT SELECTOR on this unit from standby mode.

NOTE

Power continues to be supplied to some of the circuitry even when the power is in the standby mode. When leaving home for long periods of time or when going on vacation, either press **AMP** to turn off the power, or unplug the power cord from the power outlet.

Turning the power off

Press **AMP** on the unit.

- Power is turned off.
- All indicators will turn off.

Turning speaker output on

Press **SPEAKERS** on the unit.
SPEAKERS indicator lights.

Selecting the input source

Use **INPUT** **▲▼** to be played back.

The selected input source appears on the display.



You can also select the input source by turning INPUT SELECTOR on the main unit.

Adjusting the volume

Use **VOLUME** **▲▼** to adjust the volume.



You can also adjust the volume by turning VOLUME on the main unit.

Turning off the sound temporarily

Press ATT.

"ATT" appears on the display and the sound is muted.



- To restore the sound, press the button again.



To restore the sound, press the button again.

Setting the attenuation level when sound is muted

The attenuation level can be set at -20 dB, -40 dB, or -∞.

- The factory default setting is -20 dB.

1 Press and hold ATT on the unit for 2 seconds or longer.

The attenuation level will appear on the display.



2 Press ATT on the unit.

The attenuation level setting value changes each time the button is pressed.



If not operated for 2 seconds, the current setting is saved and the display returns to normal.

Adjusting the left and right channel balance

The volume level of the left and right channels can be trimmed in 0.5 dB steps across a 0.0 – 9.0 dB range.

The factory default setting is 0.0 dB (maximum).

1 Press MENU.

The unit enters the level adjustment mode.

- The left channel level value flashes.



2 Use ▲▼ to adjust the left channel level.



3 Press ►.

The adjustment mode selects the right channel.

- The right channel level value flashes.



4 Use ▲▼ to adjust the right channel level.

5 Press MENU.

The unit exits the adjustment mode.

- If you have connected a "SLAVE" device using the F.C.B.S. connection (page 10), proceed to the slave setting.

Adjusting the tone

1 Press TONE.

The TONE indicator lights, and the mode switches to the tone adjustment mode.

2 Turn BASS and TREBLE to adjust the tone.



Press TONE again to switch the tone adjustment mode off. The TONE indicator turns off.

Settings

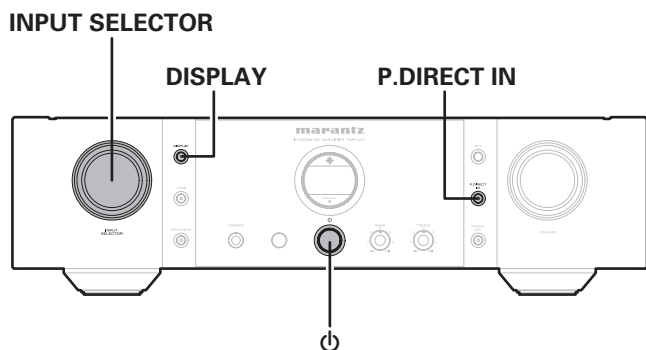

Setting ID number for F.C.B.S

When the unit is turned on, the display shows the ID number for three seconds.



For a master unit, ID number 1 needs to be assigned.
For a slave unit, set any of ID numbers 2 to 4.

- 1 While holding **DISPLAY** on the unit, press **⏻**.



- 2 Turn **INPUT SELECTOR** on the unit to select an ID number.



- 3 Turn the unit off.

- 4 Again turn the unit on.

- The setting is saved.
- The unit registered as a slave shows "SLAVE" on the display.

NOTE

- If using this unit by itself as a stereo amplifier, set the ID number to "0" (Default setting is "0").
- If the ID number is set to a number other than "0", this unit cannot be used for standalone operation.

Setting the power amp direct mode

When a pre-amplifier is connected to this unit and the unit is used as a power amplifier, follow the instructions below to turn power amp direct mode on.

- The power amp direct mode is turned off in the factory default settings.

Turning power amp direct mode on

Press and hold P.DIRECT IN on the unit for 3 seconds or longer.

"POWER AMP DIRECT" is appears on the display .

Turning power amp direct mode off

Press and hold P.DIRECT IN on the unit for 3 seconds or longer.

"POWER AMP DIRECT" disappears from the display.

NOTE

- When the power amp direct mode is on, adjustment of the volume, balance and tone on the main unit has no effect. Adjust the volume on the pre-amplifier.
- When the power amp direct mode is on, the main unit outputs at maximum volume. Check the output level on the input device before playing it and adjust the volume accordingly.

Switching the illumination lamp setting

The illumination lamps on the both sides of the unit main panel can be turned on or off.

- The illumination lamp is set to on in the factory default settings.

Turning the illumination lamp off

Press and hold DISPLAY on the unit for 2 seconds or longer.

The illumination lamps turn off.

Turning the illumination lamp on

Press and hold DISPLAY on the unit for 2 seconds or longer.

The illumination lamps light.

Setting the Auto Standby mode

You can set the unit to automatically switch to standby mode if the unit is not operated for 30 minutes when there is no audio input.

Auto Standby mode is set to on by default.

Turning Auto Standby mode off

Press and hold TONE on this unit for 5 seconds or longer.

"AUTO STBY OFF" appears on the display.

Turning Auto Standby mode on

Press and hold TONE on this unit for 5 seconds or longer.

"AUTO STBY ON" appears on the display.



- This unit will automatically enter standby mode after about continuous 30 minutes in the following conditions.
 - No operation performed on the remote control.
 - No operation of this unit.
- The display will show the remaining time for three minutes before the units enters standby mode.
- In F.C.B.S. connection, only the ID 1 master unit activates Auto Standby mode. If the ID 1 master unit is operated with no audio input, set the Auto Standby mode to off.

Tips

Tips

❑ I want to adjust the tone myself

- You can adjust the tone as desired using the BASS and TREBLE knobs and the balance adjustment function (👉 page 17).

❑ I want to adjust the attenuation level when muting sound

- The attenuation level can be set at -20 dB, -40 dB, or $-\infty$ (👉 page 17).

❑ I want to use this unit as a power amplifier

- Turn the power amp direct mode on (👉 page 18).

❑ I want to use this unit as a pre-amplifier

- Connect the power amplifier to the PRE OUT connectors of this unit (👉 page 14).

❑ I want to turn the illumination lamps on both sides of the unit main panel off

- Turn the illumination lamp setting off (👉 page 19).

❑ I want to use two or more of these units for high quality playback

- Use the stereo complete bi-amp connections (👉 page 11).
- Use the multi-channel playback connections (👉 page 12).

❑ I want to use this unit's remote control to operate a Marantz CD player

- Switch the remote control control mode to CD.
- Also refer to the CD player Owner's Manual.

Troubleshooting

❑ Are the connections correct?

❑ Is the unit being operated as described in the owner's manual?

❑ Are the other components operating properly?

If this unit does not operate properly, check the items listed in the table below. If the problem persists there may be a malfunction.

In that case, disconnect the power immediately and contact your retail outlet.

Contents

| | |
|--|------|
| Power does not turn on / Power is turned off | (21) |
| Operations cannot be performed through the remote control unit | (21) |
| No sound comes out | (22) |
| Desired sound does not come out | (22) |
| Sound is interrupted or noise occurs | (22) |
| Error messages | (23) |

❑ Power does not turn on / Power is turned off

| Symptom | Cause | Page |
|---|--|--------------|
| Power does not turn on. | <ul style="list-style-type: none"> • Check whether the power plug is correctly inserted into the power outlet. | 15 |
| Power automatically turns off. | <ul style="list-style-type: none"> • The Auto Standby mode is set. The Auto Standby mode switches the unit to standby mode when the unit is not operated for approximately 30 minutes. To disable the Auto Standby mode, press and hold the TONE button on the unit for more than 5 seconds when the Auto Standby mode is enabled. | 19 |
| Power turns off and the power indicator flashes in red approx. every 2 seconds. | <ul style="list-style-type: none"> • Due to the temperature rise within this unit, the protection circuit is working. Turn off the power and wait about an hour until this unit sufficiently cools down. Then, turn on the power again. • Please re-install this unit in a place having good ventilation. | 24 – |
| Power turns off and the power indicator flashes in red approx. every 0.5 seconds. | <ul style="list-style-type: none"> • A speaker with impedance not supported by this unit is used. Please use speakers which have the specified impedance. • Check the speaker connection. The protection circuit may have been activated because speaker cable core wires came in contact with each other or a core wire was disconnected from the connector and came in contact with the rear panel of this unit. After unplugging the power cord, take corrective action such as firmly re-twisting the core wire or taking care of the connector, and then reconnect the wire. • Turn down the volume and turn on the power again. | 7 7 16 |
| Even applying power, the power display flashes red at intervals of approximately 0.5 seconds. | <ul style="list-style-type: none"> • This unit's amplifier circuit has failed. Turn off the power and please contact the Marantz service adviser. | – |

❑ Operations cannot be performed through the remote control unit

| Symptom | Cause | Page |
|---|--|------|
| Operations cannot be performed through the remote control unit. | <ul style="list-style-type: none"> • Batteries are worn out. Replace with new batteries. | 2 |
| | <ul style="list-style-type: none"> • Operate the remote control unit within a distance of about 23 ft/7 m from this unit and at an angle of within 30°. | 2 |
| | <ul style="list-style-type: none"> • Remove any obstacle between this unit and the remote control unit. | – |
| | <ul style="list-style-type: none"> • Insert the batteries in the proper direction, checking the ⊕ and ⊖ marks. | 2 |
| | <ul style="list-style-type: none"> • The set's remote control sensor is exposed to strong light (direct sunlight, inverter type fluorescent bulb light, etc.). Move the set to a place in which the remote control sensor will not be exposed to strong light. | – |
| | <ul style="list-style-type: none"> • When using a 3D video device, the remote control unit of this unit may not function due to effects of infrared communications between units (such as TV and glasses for 3D viewing). In this case, adjust the direction of units with the 3D communications function and their distance to ensure they do not affect operations from the remote control unit of this unit. | – |
| | <ul style="list-style-type: none"> • Press the AMP MODE button to switch the remote control operating mode to "AMP". | 6 |

❑ No sound comes out

| Symptom | Cause | Page |
|---------------------------------|--|------|
| No sound comes out of speakers. | • Check the connections for all devices. | 7 |
| | • Insert connection cables all the way in. | – |
| | • Check that input connectors and output connectors are not reversely connected. | – |
| | • Check cables for damage. | – |
| | • Check that speaker cables are properly connected. Check that cable core wires come in contact with the metal part on speaker terminals. Also, securely tighten speaker terminals. Check speaker terminals for looseness. | 7 |
| | • Check that a proper input source is selected. | 16 |
| | • Adjust the volume. | 16 |
| | • Cancel the mute mode. | 17 |
| | • Press the SPEAKERS button on the unit. | 16 |

❑ Desired sound does not come out

| Symptom | Cause | Page |
|---|---|------|
| No sound comes out of a specific speaker. | • Check that the speaker cable is properly connected. | 7 |
| | • Adjust the left and right channel balance. | 17 |
| The left and right of stereo sound is reversed. | • Check whether the left and right speakers are connected to the correct speaker terminals. | 7 |

❑ Sound is interrupted or noise occurs

| Symptom | Cause | Page |
|--|--|------|
| When playing a record, the sound is distorted. | • Adjust to a proper needle pressure. | – |
| | • Check the tip of the needle. | – |
| | • Replace the cartridge. | – |
| When playing a record, a humming noise comes out of the speakers. | • Check that the turntable is connected correctly. | 8 |
| | • If there is a TV or AV device near the turntable, such devices may affect the playback sound. Install the turntable in a location as far away as possible from the TV or other AV devices. | – |
| When playing a record at high volume, a “howling” sound comes out of the speakers. | • Install the turntable and speakers as far from each other as possible. | 8 |
| | • The vibrations from the speakers are being transmitted to the player through the floor. Use cushions, etc., to absorb the speakers’ vibrations. | – |

Error messages

When multiple amplifiers are connected by F.C.B.S., the error messages described in the table below may be displayed on the display. In such a case, ID number setting or remote cable connection may be in failure. Check the ID number or remote cable connection, referring to the table below. For details on ID number setting, see "Setting ID number for F.C.B.S" (🔍 page 18).

| | Indication | Meaning |
|--|------------|--|
| 1 | ERROR 02 | Multiple amplifiers take ID No. 2. |
| 2 | ERROR 03 | Multiple amplifiers take ID No. 3. |
| 3 | ERROR 04 | Multiple amplifiers take ID No. 4. |
| → Assign different ID numbers to the amplifiers. | | |
| 4 | ERROR 11 | The amplifiers with ID Nos. 2-4 cannot communicate with the amplifier with ID No. 1. |
| → If the amplifier with ID No. 1 is not on, turn it ON. | | |
| → Check that the remote cable is properly connected. | | |
| 5 | ERROR 12 | The amplifier with ID No. 1 cannot communicate with the amplifiers with ID Nos. 2-4. |
| → If multiple amplifiers take ID No. 1, set ID numbers properly. | | |
| → If the amplifier with ID No. 1 is connected to the amplifier with ID No. 0, set ID numbers properly. | | |
| → Check that the remote cable is properly connected. | | |

Appendix

Explanation terms

MM/MC cartridge select

There are two types—MM (Moving Magnet) and MC (Moving Coil)—of cartridges for turntable.

As the output levels for these two types of cartridges differ, the setting of the phono equalizer that is mounted in this unit must be switched according to the type of cartridge for your turntable. For switching, use the PHONO MC button on this unit.

Speaker impedance

This is an AC resistance value, indicated in Ω (Ohms). Greater power can be obtained when this value is smaller.

Protection circuit

This is a function to prevent damage to devices within the power supply when an abnormality such as an overload, excess voltage occurs or over temperature for any reason. If a malfunction occurs in this unit, the power indicator blinks red and the unit switches to standby mode.

About the protection circuit

This unit is equipped with a protection circuit to protect the amplifier circuits and speaker system from damage. If the protection circuit is activated, the sound is instantly muted.

In this case, the message "PROTECT" flashes on the display panel, and the STANDBY indicator also flashes.

To deactivate the protection circuit, turn the unit off then back on again after about 1 minute or more.

At power on

For about 8 seconds after the power is turned on, the protection circuit is activated, muting the sound to give the amplifier circuits time to stabilize. Once the amplifier circuits stabilize, the protection circuit is released, and audio is enabled.

In the event of overcurrent

The protection circuit is activated if current exceeding a certain level is detected, which can happen if excessive signal flow is input to the amplifier or if the unit is connected to a speaker system of less than 4 Ω /ohms impedance. The protection circuit is also activated if a speaker cable shorts.

In such cases, the message "PROTECT" flashes on the display, and the volume is automatically reduced. After approximately 8 seconds, the protection circuit is released. Therefore, the volume needs readjusting to continue normal use.

If the overcurrent continues, the amplifier shuts itself OFF, and the STANDBY indicator flashes.

To deactivate the protection circuit, turn the unit off then back on again after about 1 minute or more.

If excessive ultrabass signals are input

The protection circuit is also activated if ultrabass signals are input. In such a case, the STANDBY indicator flashes, and the volume is automatically reduced. After approximately 8 seconds, the protection circuit is released. Therefore, the volume needs readjusting to continue normal use. If excessive ultrabass signal input continues or if DC voltage is detected owing to trouble with the amplifier, the amplifier shuts itself OFF, and the STANDBY indicator flashes.

To deactivate the protection circuit, turn the unit off then back on again after about 1 minute or more.

If the main-amplifier overheats

The protection circuit is activated if the temperature of the main amplifier section rises above a certain level, which can happen if the amplifier is continuously used with excessive signal flow being input to it. The protection circuit is also activated when the specified operating temperature is exceeded, which can happen if the vents on top of the amplifier are covered or if the amplifier is installed on a cramped audio rack. In such a case, the STANDBY indicator flashes, and the volume is automatically reduced. After approximately 8 seconds, the protection circuit is released. Therefore, the volume needs readjusting to continue normal use.

If the temperature does not sufficiently fall within a certain amount of time after the protection circuit activation, the amplifier shuts itself OFF, and the STANDBY indicator flashes. To deactivate the protection circuit, turn the unit off, let it stand until it cools down, then turn it ON again.

In the event of amplifier trouble

The protection circuit is activated, and the power is automatically shut OFF, if an abnormality is detected in the power circuit. The same happens if the main fuse inside the amplifier blows. In such cases, the STANDBY indicator flashes.

Turn the unit off then after several minutes turn it on again. If the display does not light up, and the STANDBY indicator remains flashing after the unit is turned on again, the unit may be in failure.

Specifications

| | |
|---|---|
| • RMS Power output: (20 Hz – 20 kHz 2-channel simultaneously driven) | 90 W × 2 (8 Ω/ohms) 140 W × 2 (4 Ω/ohms) |
| • Total harmonic distortion: (20 Hz – 20 kHz 2-channel simultaneously driven, 8 Ω/ohms) | 0.05 % |
| • Output band width: (8 Ω/ohms, 0.05 %) | 5 Hz – 40 kHz |
| • Frequency response: (CD, 1 W, 8 Ω/ohms load) | 5 Hz – 100 kHz ± 3 dB |
| • Damping factor: (8 Ω/ohms, 20 Hz – 20 kHz) | 100 |
| • Input sensitivity/Input impedance | |
| PHONO (MC): | 270 μV / 100 Ω/ohms |
| PHONO (MM): | 2.7 mV / 47 kΩ/kohms |
| CD/LINE: | 240 mV / 20 kΩ/kohms |
| P. DIRECT IN: | 1.7 V / 20 kΩ/kohms |
| • Output voltage/Output impedance | |
| PRE OUT: | 1.7 V / 220 Ω/ohms |
| • Maximum allowable PHONO input level (1 kHz) | |
| MC: | 15 mV |
| MM: | 150 mV |
| • RIAA deviation: (20 Hz–20 kHz) | ± 0.5 dB |
| • S/N (IHF-A, 8 Ω/ohms) | |
| PHONO (MC): | 75 dB (0.5 mV Input, 1 W Output) |
| PHONO (MM): | 86 dB (5 mV Input, 1 W Output) |
| CD/LINE: | 106 dB (2 V Input, Rated output) |
| • Tone control | |
| BASS (50 Hz): | ± 10 dB |
| TREBLE (20 kHz): | ± 10 dB |
| • Power requirement: | AC 120 V, 60 Hz |
| • Power consumption (UL60065): | 220 W |
| • Standby power consumption: | 0.2 W |

For the purpose of improvement, the specifications and design are subject to change without notice.

Index

A

| | |
|----------------------------|----|
| Accessories | 1 |
| Adjusting the tone | 17 |
| Adjusting the volume | 16 |
| Auto Standby mode | 19 |

C

| | |
|-----------------------------------|----|
| Cables used for connections | 7 |
| Connection | |
| 5.1 multi-channel playback | 12 |
| F.C.B.S. | 10 |
| Player | 8 |
| Power amplifier | 14 |
| Power cord | 15 |
| Pre-amplifier | 14 |
| Recorder | 9 |
| Remote control connectors | 15 |
| Speaker | 8 |
| Stereo complete bi-amp | 11 |

F

| | |
|-------------------|---|
| Front panel | 4 |
|-------------------|---|

M

| | |
|------------------------------|----|
| MM/MC cartridge select | 24 |
|------------------------------|----|

P

| | |
|--------------------------|----|
| Protection circuit | 24 |
|--------------------------|----|

R

| | |
|-------------------------------|---|
| Rear panel | 5 |
| Remote control unit | 6 |
| Inserting the batteries | 2 |

S

| | |
|----------------------------------|----|
| Selecting the input source | 16 |
| Speaker impedance | 24 |

T

| | |
|---|----|
| Tips | 20 |
| Troubleshooting | 20 |
| Turning off the sound temporarily | 17 |
| Turning the power on | 16 |



Dimensions / Dimensions / Dimensions

Unit / Unité / Unidad / : inch (mm)

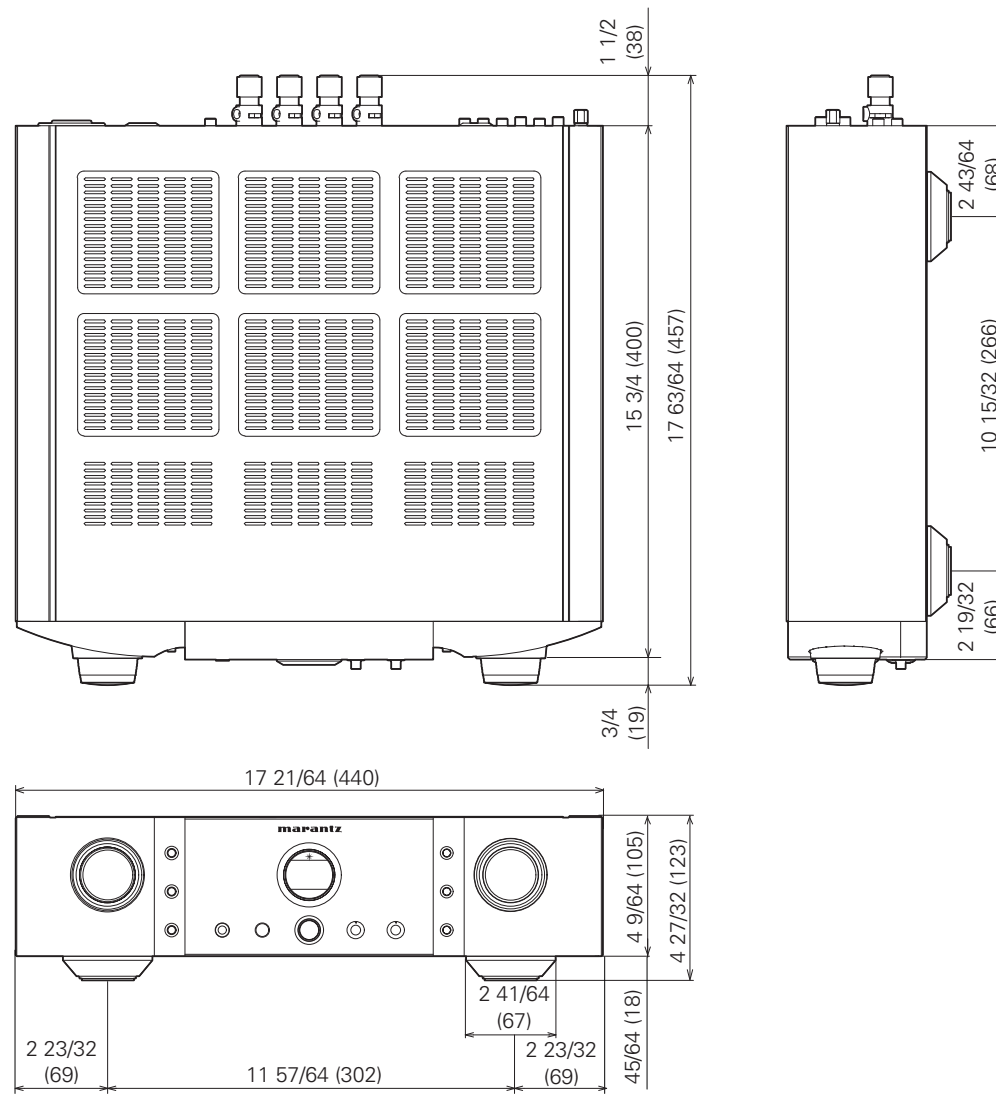

Weight / Poids / Peso / : 40 lbs 13 oz (18.5 kg)

www.marantz.com

You can find your nearest authorized distributor or dealer on our website.

marantz[®] is a registered trademark.